

## **SPECIFICATION OF *THE STANDARD* SHOWCAGE**

**FOR THE AUSTRALIAN NATIONAL BUDGERIGAR COUNCIL (Inc) AS AMENDED –  
DECEMBER 2003**

**REVISION "D" DECEMBER 2003**

### **PREAMBLE**

This specification and accompanying drawings is a performance document and compliance with the written word and/or drawings does not of itself mean acceptance of any cage. Acceptance or rejection of any cage shall be based on inspection by the rules of individual state requirements.

The primary objective of this specification and the accompanying drawings is that all show cages will be identical and indistinguishable from other standard show cages. The written description and drawings is an aid to achieve this objective.

The second objective of these documents is to ensure that standard cages have a useful life in excess of ten years, when used under normal circumstances and conditions.

Provided the materials and method of construction closely comply with the specification requirements such a life should be achieved with periodic repainting as necessary.

Copyright of the design contained in this specification and accompanying drawing is retained by the ANBC (Inc). Authority to reproduce this documentation in whole or in part must be obtained in writing from the Secretary of the ANBC (Inc).

### **WORKMANSHIP**

Perform all operations necessary in first class joiners work. Ensure finished work is true, straight and square. Dress all visible edges with sandpaper to 0.5mm radius. The dimensions of the completed cage shall be within the tolerances shown on the drawing. All dimensions are in millimetres.

### **PLYWOOD**

Plywood used for construction of the cage shall comply with Australian Standard AS2271-1979.

Plywood used shall be "A" type bond.

4mm thick plywood shall be 3 ply construction.

6mm and 9mm thick plywood shall be 5 ply construction.

Plywood finishes for both faces shall be either a B grade finish or shall be provided with a medium density overlay.

All joints between plywood shall be made using a high solids fast drying high grade general purpose PVA adhesive. Prior to application of adhesive plywood with a medium density overlay, if used, shall have the contact areas intentionally roughened.

All joints between plywood panels shall be nailed using 15mm long x 1.0mm dia. Brad head nails at the locations shown on the drawing.

## **DOOR**

The door shall be hinged at the top with a 38 x 27 cadmium plated cabinet series butt hinge. Each hinge leaf shall be double armed. The hinge shall be fixed to the door and cage by 4 - 6 x 1/4 self tapping zinc plated Pan/Phillips head screws.

The door shall be secured by a 30mm brass box hook fixed to the door with 1-6 x 1/4 head screw. The stop to the box hook shall also be 1-6x1/4 self tapping zinc plated Pan/Phillips head screw located as shown on the drawing. Additional security may be provided to the door by:

1. Attaching a brass canteen clip JW 1591-8 5 fixed at the position of one o'clock by a 1-6 x 1/4 self tapping zinc plated Pan/Phillips head screw. Pressure tightened to allow movement.
2. Attaching a brass canteen clip JW 1591-8 5 fixed at the position of three o'clock by a 1-6 x 1/4 self tapping zinc plated Pan/Phillips head screw. Pressure tightened so as not to allow movement.
3. Attaching a 75mm x 18mm strip of black self adhesive electrical tape placed horizontally over the brass box hook
4. Attaching any (or all) of the above.

## **PAINTING**

All timber surfaces and the door hinge and screws shall be painted. The door brass box hook, canteen clip and associated screws shall be unpainted.

Prepare surfaces so they are free from contaminants, make good surface and joint imperfections. Joints shall not be visible in the completed cage.

Paints shall be of prime quality conforming to the relevant Australian Standard Specification and Government Proved Certificate. All paint shall be supplied by a recognised nationally based paint manufacturer. Paints used shall be compatible with each other as determined by reference to manufacturers recommendations.

The interior of the cage, including the top of the bottom rail, shall be painted with two coats of acrylic based wood primer followed by three coats of gloss acrylic water based gloss white.

The exterior of the cage shall be painted with two coats of acrylic based wood primer, followed by three coats of oil based full gloss enamel black or three coats of gloss acrylic based gloss black.

Full gloss estapol (clear finish) coating to the exterior of the cage shall be permitted to protect the exterior surfaces.

## HARDWARE

Attached is an appendix which lists various components of the cage. This specification does not intend to nominate the source of supply. Manufacturers are however advised to consider the consequences of the method of acceptance of cages to this specification under the Preamble heading.

## WELDED WIRE FRONT

The wire used for fabrication of the cage front shall be 2.0mm and 2.5mm diameter standard bright hard drawn low carbon (C = 0.12%C) general purpose manufacturing wire.

The set down at welded intersections shall be approximately 10%. The welding procedure shall be sufficient to develop at least 100 MPa tension in either wire when tested in weld shear under a similar procedure to that set down in Appendix B of AS 13 04 -1984 Welded Wire Reinforcing Fabric for Concrete.

The welded wire front shall be chromium plated in accordance with AS 1192-1982 Electroplated Coatings - Nickel & Chromium and shall meet the following requirements.

The front shall be properly cleaned prior to the plating process. The coating shall be copper plus nickel plus chromium on steel for a Service Condition Number 2 as shown in Table 1.2 of AS 11992 and shall have the following classification Fe/Cu20 Nid Ob Cr r.

NOTE: A coating for service conditions number 3 with a classification such as fe/Cu15 Nid Cr r can be expected to give a significantly longer life.

The significant surface under clause 1.3 of AS 1192 is the entire front. The significant surface shall be free from visible defects such as blisters, pits, roughness, cracks or unplated areas and shall be free of stain or discoloration.

Or,

Be Powder Coated. - *Colour:* Precious Silver Pearl Gloss. *Level:* Satin. *Brand:* Dulux. *Line NO:* 272. *Shade NO:* 57225.

NOTE: Chromium fronts are to be phased out by 2019.

The welded wire front shall be secured in position by means of a hollow screw produced from a black finish Unbracko M4.0 x 16 long x 0.7 pitch socket head grub screw drilled out to produce a 2.5mm diameter hollow core to accommodate the central vertical wire of the welded wire front.

## DRINKER

A drinker manufactured to the dimensions shown on the drawing shall be installed immediately above the mid wire of the front between the fourth and fifth vertical wires from the left when the cage is viewed from the front. *The Standard Showcage* shall always be used with a drinker installed even in areas where drinkers are not required by legislation.

The welded wire front shall be secured in position by means of a hollow screw produced from a black finish Unbracko M4.0 x 16 long x 0.7 pitch socket head grub screw drilled out to produce a 2.5mm diameter hollow core to accommodate the central vertical wire of the welded wire front.

## **PERCH**

The perch will be of a good quality 16mm dowel 149mm long with outer edges left square and positioned as described in diagrams ANBC1c and TC-1 to extend in line with the outer edge of the front board. The cutout will be a horizontal cut of 6mm and a vertical cut of 4mm meeting the horizontal cut thus removing a small block out of the bottom end of the perch. The vertical slot will be 4mm deep to suit 2mm diameter wire front bar.

The perch will be fixed either with a 1mm diameter pin with 3mm extension, or, screwed with 1/No.6 x 3/4 self tapping zinc plated, Pan/Phillips head screw.

NOTE: Both 12.00mm and 16.00mm perches are optional until 2015 ANBC show completion however common perch sizing must be used by the various host states until that date.

NOTE 2: Refer to Standard Show Cage Drawing for dimensions and construction of 12mm perches.

## **APPENDIX**

6mm Crezon faced plywood or Craftwood or Lake Pine.

4mm & 9mm exterior grade "A" type bond plywood.

30 brass box hook from Howard V. Parkes Fairfield Victoria.

6x1/4 self tapping zinc plated Pan/Phillips head screws by Spurway Cooke.

Canteen Clip (safety clip) JW 1591-85 from Howard V Parkes Fairfield Victoria

Drinkers from Pacemaker Plastics Moorabin Victoria.

3/16 BSW x 5/8 Unbracko grub screw

38 x 27 cadium plated cabinet series butt hinge available from Warlan Pty. Ltd. South Australia.

DRAWING - STANDARD SHOWCASE

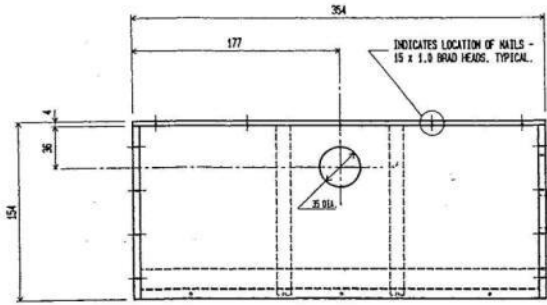

PLAN VIEW

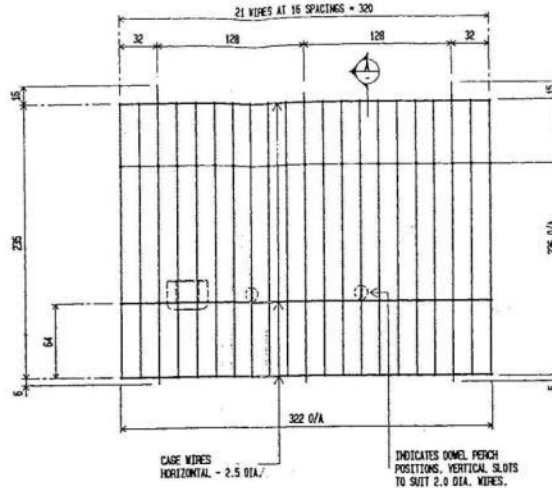

ELEVATION - WIRE CAGING

NOTE: CAGE WIRES - 2.0 DIA. / 2.5 DIA. TO BE CHROMIUM PLATED IN ACCORDANCE WITH SHOWCASE SPECIFICATION.

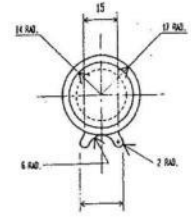
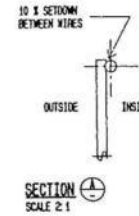

PLAN - DRINKER

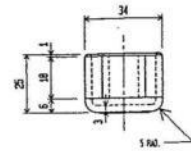

ELEVATION - DRINKER  
SCALE 1:1

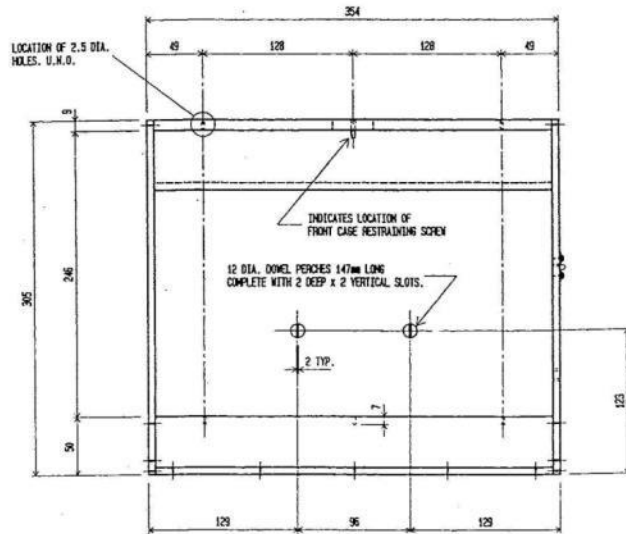

FRONT ELEVATION

WIRE CAGING NOT SHOWN FOR CLARITY. REFER ELEVATION FOR WIRE CAGING DETAILS.

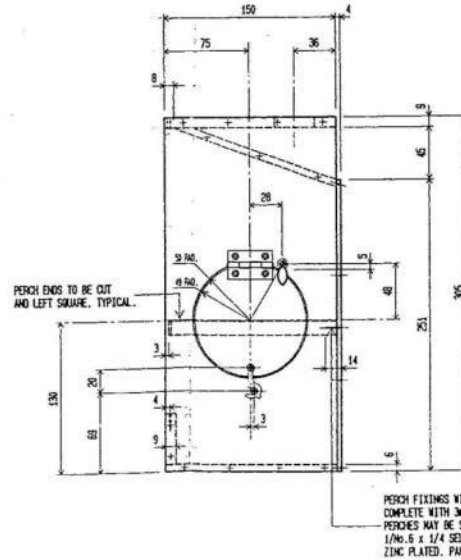

END ELEVATION

PROVIDE 4/No. 6 x 1/4 SELF TAPPING ZINC PLATED PAN/PHILLIPS HEADSCREWS, TYPICAL.

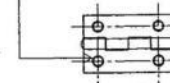

40 x 25 CABINET SERIES BUTT HINGES SCALE 1:1

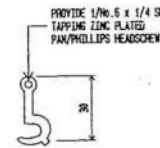

30 BRASS BOX HOOK  
SCALE 1:1

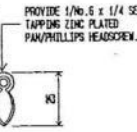

BRASS CUTLERY CLIP  
SCALE 1:1

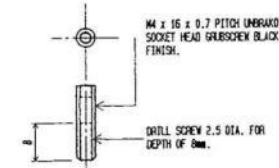

FRONT RESTRAINING SCREW  
SCALE 2:1

- NOTES
1. DIMENSIONAL TOLERANCES:  
SIZE 100 OR LESS = ± 1.0mm  
SIZE GREATER THAN 100 = ± 2.0mm
  2. MATERIALS FOR CONSTRUCTION TO BE IN ACCORDANCE WITH SHOWCASE SPECIFICATION.
  3. FINISHES:  
WIRE FRONT - BRIGHT CHROME (REFER SPEC.)  
DOOR CATCH - BRASS FINISH  
SAFETY CATCH - BRASS FINISH  
DOOR STOP - CADMIUM FINISH  
DOOR HINGE & SCREWS - GLOSS BLACK

PLYWOOD CASE INTERIOR INCLUDING TOP OF BOTTOM RAIL - ACRYLIC GLASS WHITE  
EXTERIOR - GLOSS BLACK

REFER SHOWCASE SPECIFICATION FOR PAINTING REQUIREMENTS.

COPYRIGHT BY DESIGN GROUP HEREIN IS RETAINED BY AUSTRALIAN NATIONAL BUDGERIGER COUNCIL. AUTHORITY IS REQUIRED FOR REPRODUCTION.

Item	Description	Qty	Unit Price	Total
C	CLIP WIRE/PERCH/NOSE	150	\$5.00	\$750.00
B	PERCH/NOSE	150	\$4.00	\$600.00
A	DOOR L.H.C. PERCH/DOOR/DRINKER	150	\$14.00	\$2100.00

AUSTRALIAN NATIONAL BUDGERIGER COUNCIL STANDARD SHOWCASE

Drawn: R.A.  
Date: AUGUST 1992  
Scale: 1:2.0 X 0.  
Checked: [Signature]  
Approved: [Signature]  
Project No. [Blank]      Drawn By: [Signature]      ANBC1c

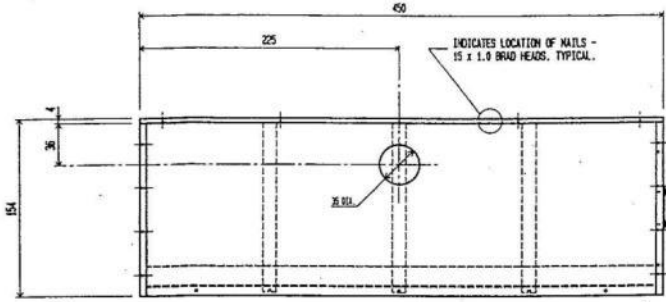

PLAN VIEW

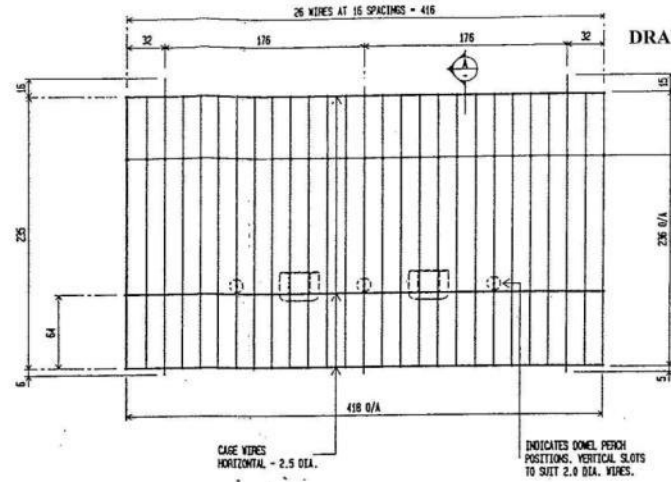

ELEVATION - WIRE CAGING

NOTE: CAGE WIRES - 2.0 DIA. / 2.5 DIA. TO BE CHROMIUM PLATED IN ACCORDANCE WITH SHOWCASE SPECIFICATION.

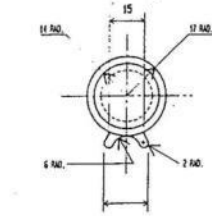

PLAN - DRINKER

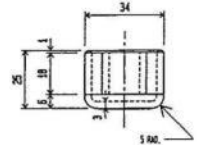

ELEVATION - DRINKER  
2 OFF REQ'D. SCALE 1:1

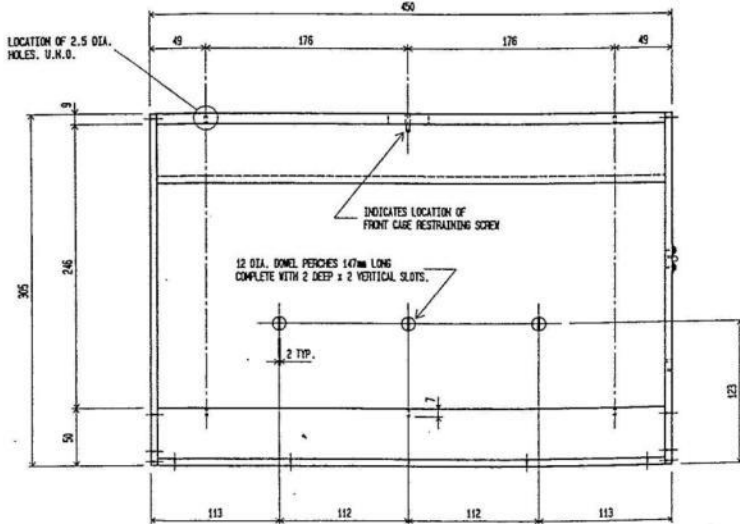

FRONT ELEVATION

WIRE CAGING NOT SHOWN FOR CLARITY. REFER ELEVATION FOR WIRE CAGING DETAILS.

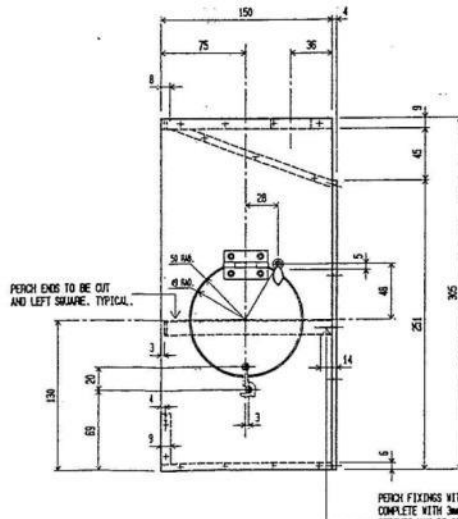

END ELEVATION

PROVIDE 4/No. 6 x 1/4 SELF TAPPING ZINC PLATED PAN/PHILLIPS HEADSCREWS, TYPICAL.

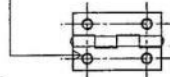

40 x 25 CABINET SERIES BUTT HINGES SCALE 1:1

PROVIDE 1/No. 6 x 1/4 SELF TAPPING ZINC PLATED PAN/PHILLIPS HEADSCREW.

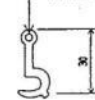

30 BRASS BOX HOOK SCALE 1:1

PROVIDE 1/No. 6 x 1/4 SELF TAPPING ZINC PLATED PAN/PHILLIPS HEADSCREW.

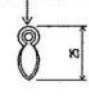

BRASS CUTLERY CLIP SCALE 1:1

M4 x 16 x 0.7 PITCH UNBRASS SOCKET HEAD GRUBSCREW BLACK FINISH.

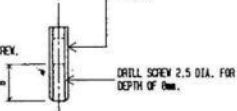

FRONT RESTRAINING SCREW SCALE 2:1

- NOTES
1. DIMENSIONAL TOLERANCES:  
SIZE 100 OR LESS ± 1.0mm  
SIZE GREATER THAN 100 ± 2.0mm
  2. MATERIALS FOR CONSTRUCTION TO BE IN ACCORDANCE WITH SHOWCASE SPECIFICATION.
  3. FINISHES:  
WIRE FRONT - BRIGHT CHROME (refer spec.)  
DOOR CATCH - BRASS FINISH  
DOOR STOP - CADMIUM FINISH  
SAFETY CATCH - BRASS FINISH  
DOOR HEDGE & SCREWS - GLOSS BLACK  
PLYWOOD CAGE INTERIOR INCLUDING TOP OF BOTTOM RAIL - ACRYLIC GLOSS WHITE  
EXTERIOR - GLOSS BLACK
- REFER SHOWCASE SPECIFICATION FOR PAINTING REQUIREMENTS.

11114 STANDARD TEAM CAGE  
INCORPORATES FEATURES FROM UNIC STANDARD SHOWCASE.

Drawn: R.J.  
Date: MAY 1995  
Scale: 1:2 U.N.D.

Checked: \_\_\_\_\_  
Approved: \_\_\_\_\_  
Inscribed: \_\_\_\_\_  
Project No. \_\_\_\_\_  
TC-1